

PROJETO DRENAGEM

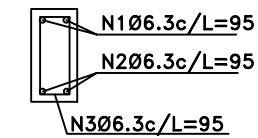

LEGENDA		CURVA DE NÍVEL		PERFIL DO TERRENO		CERCA		RM RESIDÊNCIA EM MADEIRA
		CURSO D'ÁGUA		BORDO DE TERRAPLANAGEM		MURO		RA RESIDÊNCIA EM ALVENARIA
		BUEIRO EXISTENTE		OFFSET DE ATERRO		BOCA DE LOBO		CR CONSTRUÇÃO RURAL
		EIXO PROJETADO		OFFSET DE CORTE		BUEIRO PROJETADO		POSTE
		BORDO PROJETADO		TALUDE DE CORTE		SARJETA EM CONCRETO		VEGETAÇÃO 1
		ACOSTAMENTO PROJETADO		TALUDE DE ATERRO		BOCA DE BUEIRO		VEGETAÇÃO RASTEIRA
	GRADE PROJETADO		PISTA PAVIMENTADA		DRENO PROFUNDO		LAVOURA	

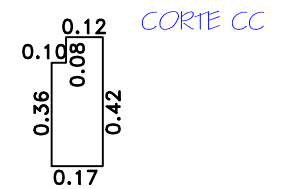
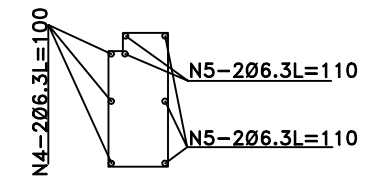
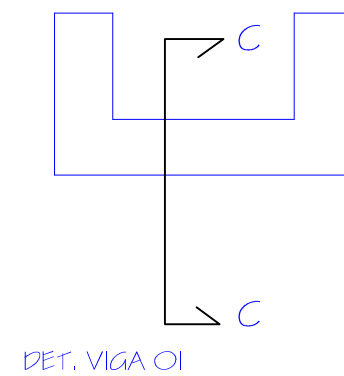
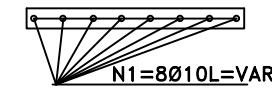
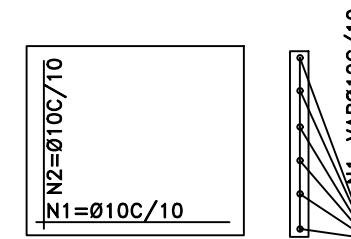
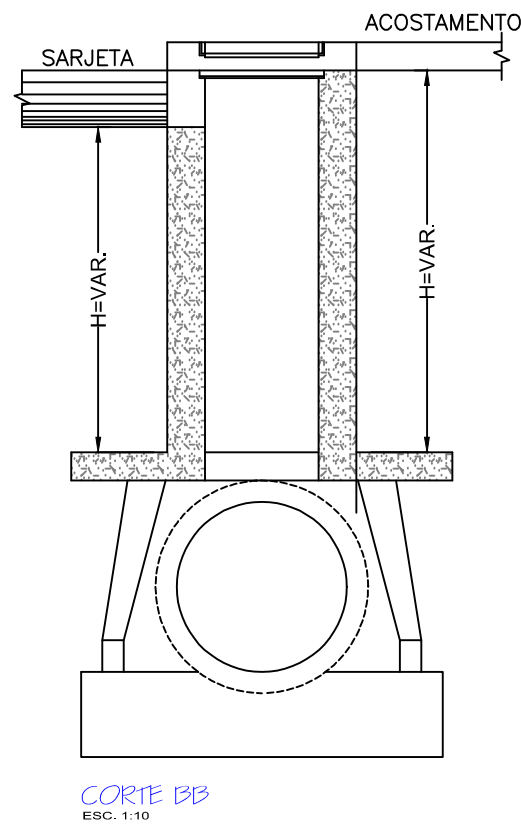
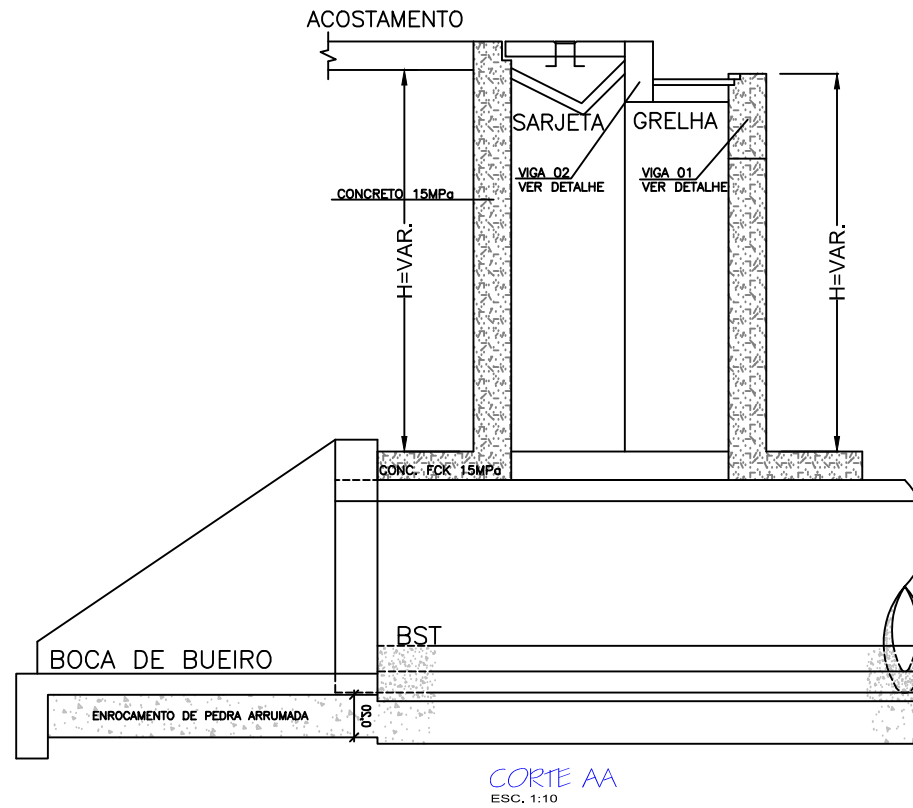
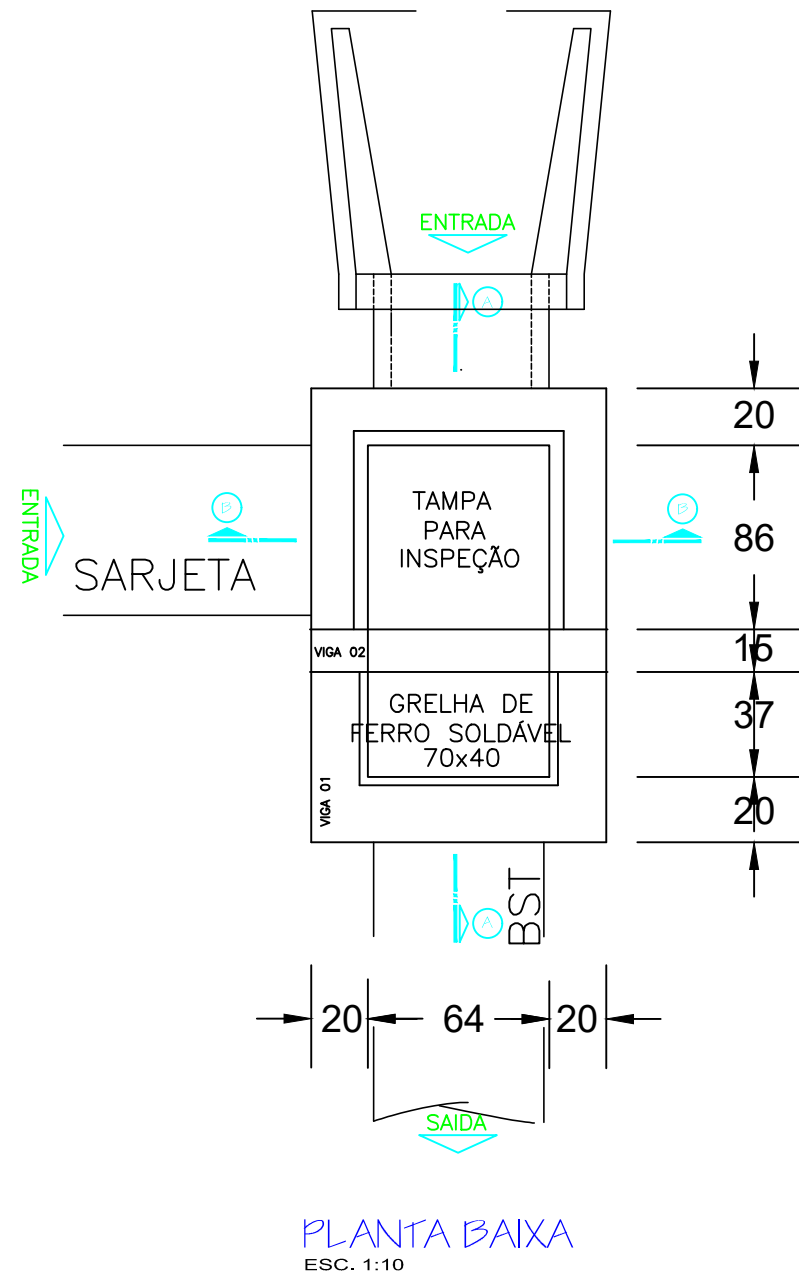

TÍTULO:	PAVIMENTAÇÃO RODOVIA LINHA UNIÃO	
REFERÊNCIA:	PROJETO EXECUTIVO	DETALHE CAIXA COLETORA TIPO 01
PROPRIETÁRIO:	MUNICÍPIO DE IBIAM	
FRANCHA:	36	
RESPONSÁVEL TÉCNICO:	RONALDO REGALIN - ENGENHEIRO CIVIL	
ESCALA:	SEM ESCALA	DATA: ABRIL/2018